

Article number: 3901210050700

Description: Worm gear with solid input shaft
VF 210P-50-HS

Measures

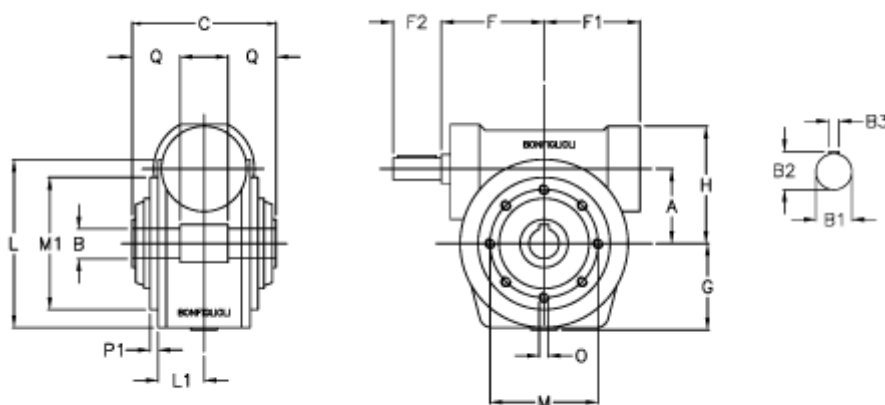

a	= 210.0	F1 = 277	O = M16x30
B	= 90	F2 = 110	P1 = 5.0
B1	= 48	g = 220	Q = 85.0
B2	= 51.5	H = 330	
B3	= 14	L = 350.0	
C	= 260	L1 = 125.0	
Description	= VF 210P-xx-HS	m = 300	
F	= 230.0	M1 = 250	